

One giant leap for safety: AZM400.

The new safety interlock for demanding applications.

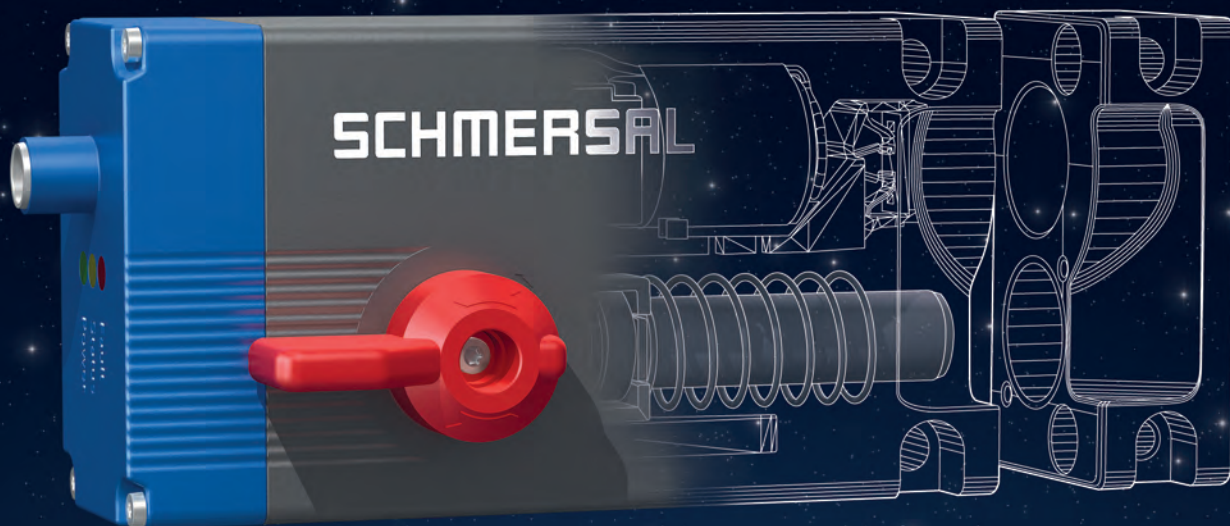

Use the QR code for details.

AZM400: Highest demands on



safety requirements.

- > Bistable, motor-driven system
- > Holding force 10.000 N
- > Release possible against lateral forces up to 300 N
- > Individually coded version with coding level „High“ according to ISO 14119
- > PL e / cat. 4 / SIL 3 for interlocking and guard locking function
- > Two-channel input signal of the guard locking function
- > Operation on P/P- and P/N-switching outputs
- > High tolerance to door misalignment
- > Up to two diagnostic outputs
- > Emergency exit or manual release
- > Optional: electric manual release with auxiliary voltage
- > Assembly set for simple installation on 40 mm aluminium profiles

Function and operation



Highest demands on safety with bistable operating principle

The AZM400 enhances the Schmersal family of safety locking devices to include a safety solenoid interlock with bolt locking. This consists of a locking unit with sensor technology and a motor-driven locking bolt, along with an actuator that features an encoded RFID-tag and a locking hole with two permanent magnets in which the locking bolt engages. Only once the safety door is in the correct position the locking bolt can be ejected. As soon as the locking bolt has reached a sufficient depth in the locking hole of the actuator, it is enabled by the system and the protection device is deemed to be secure.

The AZM400 solenoid interlock is a bistable system. In other words, the locking device remains in the last locked status in the event of a power failure. Safe operation is assured in any operating condition of the machine as even if the system is in a run-down movement and present a danger, the safety door remains securely closed if power has been cut-off.

Fields of application

- Machine tools with heavy doors
- Safety doors in machine and plant construction
- Actuated and motorised safety doors
- Heavy safety doors with high manual forces
- Safety doors in front of run-down and dangerous movements



Machine tools and tool centres

Holding force



High holding force and unlocking against lateral force

With a holding force of 10,000 N, the AZM400 solenoid interlock is particularly well suited for heavy doors.

It is not uncommon for tension to build up in the doors due to sealing lips or misalignment of the safety door. To resolve this problem, the AZM400 enables unlocking against lateral forces of up to 300 N.

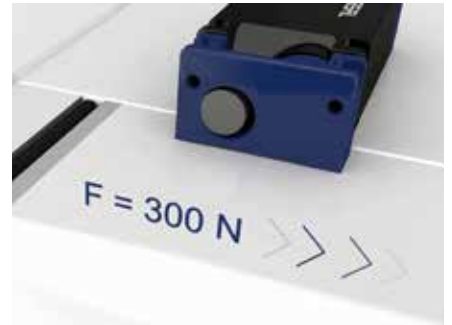

Unlocking against lateral force: 300 N

Actuator misalignment and switching distance

The actuator can be moved on both sides from the X and Y direction. In this way, simple installation in applications with sliding guards or rotating protective equipment is made possible.

Due to the high permissible actuator offset, it can also be used where large installation tolerances on safety doors are encountered.

- Actuator tolerance in X and Y direction: ± 4 mm
- Distance between actuator and solenoid interlock 1...7 mm with max. angle offset of 2°

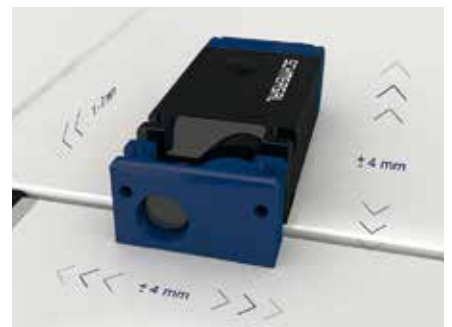

Actuator tolerances

Electric manual release

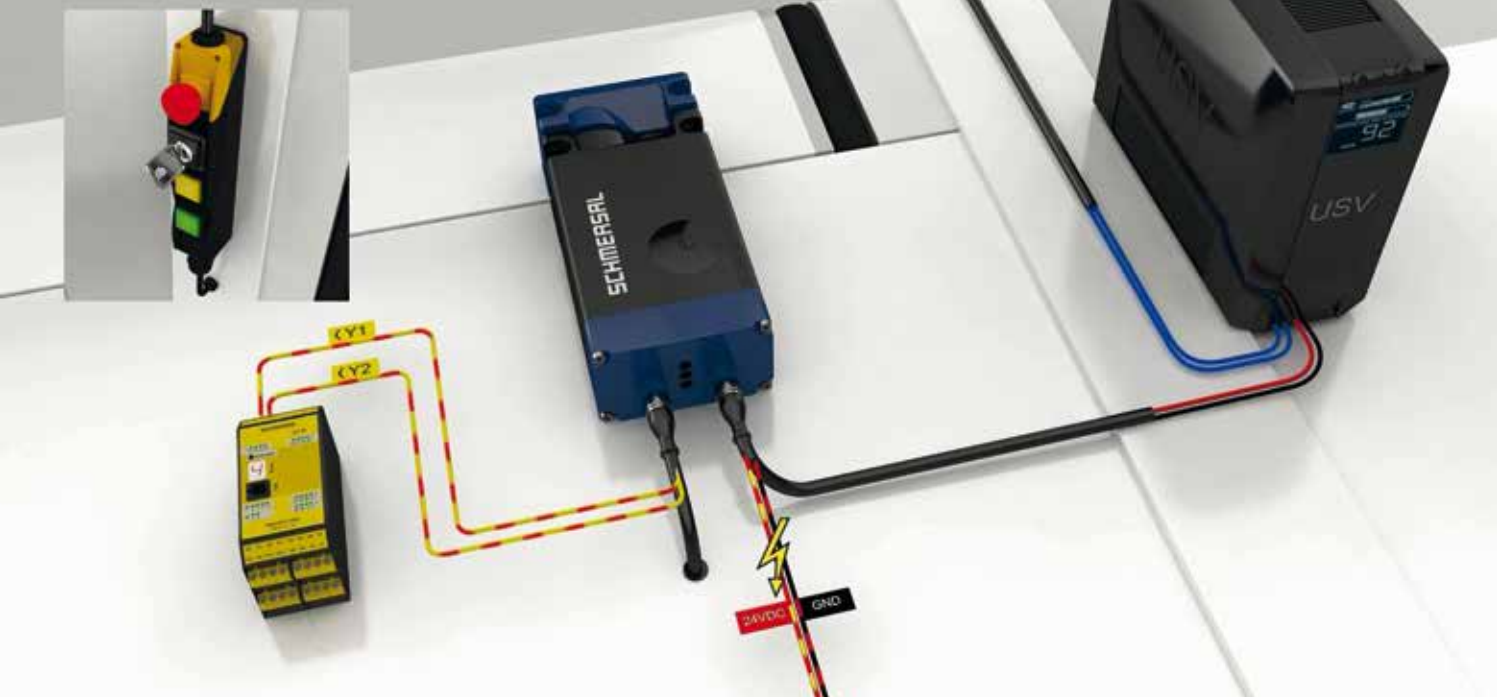

Electric manual release and enhanced diagnosis

As with most of the electronic switchgear from Schmersal, the basic version of AZM400 (-ST) is fitted with an 8-pole M12 connector. This version features a diagnostic output and two safety outputs.

The functionally enhanced version of AZM400 (-ST2) is also fitted with a 5-pole M12 connector in addition to the 8-pole M12 connector. This version is distinguished by an additional diagnostic output as well as the means by which an electric auxiliary release device can be connected.

The electric manual release of the functionally enhanced version of AZM400 (-ST2) can be realised by an additional auxiliary voltage supply. By connecting the auxiliary voltage supply, it is possible to release the device in the event of a power failure or if the main supply is switched-off.

Two-channel input signal according to ISO 14119

By means of two-channel input signal, the AZM400 meets the highest demands in safety as prescribed by ISO 14119. In this way, the interlocking function and the guard locking function fulfils PL e / category 4 / SIL 3.

The guard locking function is significant particularly for applications in which a hazardous situation could occur through unintended opening of the isolating guard system such as, for example, run-down movement causing a danger.

The new type of input circuit for actuation of the guard locking function makes it possible to connect the AZM400 to all common safety control systems. These safety control systems can be equipped both with P/P and P/N outputs. To do this, no different versions of the AZM400 are necessary.

Coding



Automatic teaching after the operating voltage is switched on



Ten minute release block during the teach-in procedure for the replacement actuator

Protection against defeating through individual coding

If interlocking devices are tampered with, the machine is no longer operated in accordance with the manufacturers specifications. As a result, the operator could be exposed to a considerably higher risk.

If tampering cannot be excluded by using modified or additional operating modes, the machine builder can only take one more measure, i.e. making the tampering of the interlocking device more difficult or impossible. (Excerpt from ISO 14119)

In its basic version, the AZM400 accepts any suitable actuator. By integrating RFID technology in the safety sensors, the coding level high can be reached for the individually encoded versions in accordance with ISO 14119. Version -I1 only accepts an actuator for which the teach-in process was run upon initial activation. With the third version -I2, this teach-in process can be repeated as many times as necessary. A release block of ten minutes prevents a quick change of the actuator and protects the system further against manipulation. In this way, the user can choose the most suitable coding variant for the intended application as well as the desired degree of protection against tampering.

Teaching actuators without additional tools

For the individually encoded versions -I1 and -I2, the teach-in process for the actuator requires no tools at all.

During initial start-up, the teach-in process starts automatically. Simply connect the holding device to the operating voltage and bring the actuator into the detection range. After about ten seconds, brief cyclic flashes indicate that the operating voltage is to be switched off. When the operating voltage is reactivated, the actuator must be brought into the detection range again in order for the generated actuator code to be activated.

The AZM400 in detail

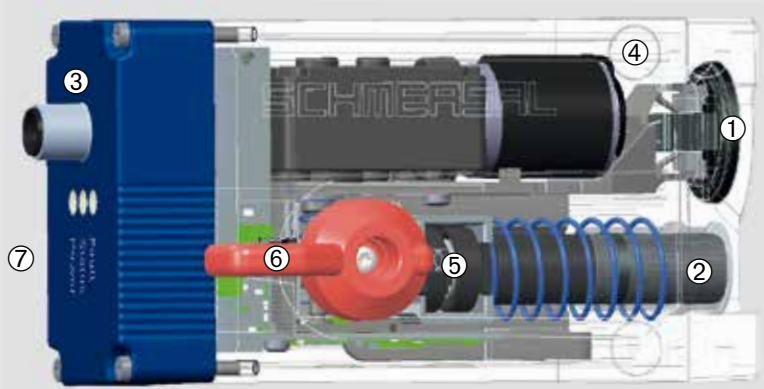

Key

- ① High protection against tampering thanks to encoded RFID sensor
- ② Motor-driven locking bolt
- ③ M12 connector plug, 8-pole
- ④ Fixing holes for M6 bolts
- ⑤ Manual release
- ⑥ Emergency exit lever
- ⑦ LED display

Detection of block run

If the locking bolt does not reach the "locked" status at the first attempt, the AZM400 makes another autonomous attempt. Only after the second attempt has failed will the AZM400 report a fault. This reduces the number of error messages and protects the device and the machine against damage.



Features



LED display

- Smart diagnostic by means of 3-colour LED's
- Red LED: Fault
- Yellow LED: Device condition
- Green LED: Supply voltage



Two connector version



- AZM400 (-ST2) version with additional M12 5-pole connector plug for connection of electric manual release and additional diagnostic output.



Manual release

- For set-up and commissioning of the machine, the solenoid interlock can be released without power with the aid of a triangular key.

Technical data

Technical data	AZM400
Holding force:	10,000 N
Unlocking against lateral force:	300 N
Mechanical life:	> 1,000,000 operations
Protection class:	IP66 / IP67
Dimensions:	157 x 78 x 47 mm
Supply voltage:	24 VDC -15% / +10%
Electrical connection:	ST: Connector plug M12, 8-pole; ST2: Connector plug M12, 8-pole / M12, 5-pole
Outputs:	ST: 1 diagnostic output, 2 safety outputs, all p-type; ST2: 2 diagnostic outputs, 2 safety outputs, all p-type;
Diagnostic and status display:	3 LED's
Classification:	ISO 13849-1, IEC 61508
- of the interlocking function:	PL e / Cat. 4 / SIL 3
- of the guard locking function:	PL e / Cat. 4 / SIL 3
Approvals:	 

Ordering details

1 connector plug ST	2 connector plugs ST2	1 diagnostic output 1P2P	2 diagnostic outputs 2P2P	Standard coding	Individual coding -I1	Individual coding, re-teaching enabled -I2	Manual release	Emergency exit T	Electric manual release E	Ordering details	Ordering code
<input type="checkbox"/>	<input type="checkbox"/>	<input type="checkbox"/>	<input type="checkbox"/>	<input type="checkbox"/>	<input type="checkbox"/>	<input type="checkbox"/>	<input type="checkbox"/>	<input type="checkbox"/>	<input type="checkbox"/>	AZM400Z-ST-1P2P	103003590
<input type="checkbox"/>	<input type="checkbox"/>	<input type="checkbox"/>	<input type="checkbox"/>	<input type="checkbox"/>	<input type="checkbox"/>	<input type="checkbox"/>	<input type="checkbox"/>	<input type="checkbox"/>	<input type="checkbox"/>	AZM400Z-ST-1P2P-T	103003593
<input type="checkbox"/>	<input type="checkbox"/>	<input type="checkbox"/>	<input type="checkbox"/>	<input type="checkbox"/>	<input type="checkbox"/>	<input type="checkbox"/>	<input type="checkbox"/>	<input type="checkbox"/>	<input type="checkbox"/>	AZM400Z-ST-I1-1P2P	103003732
<input type="checkbox"/>	<input type="checkbox"/>	<input type="checkbox"/>	<input type="checkbox"/>	<input type="checkbox"/>	<input type="checkbox"/>	<input type="checkbox"/>	<input type="checkbox"/>	<input type="checkbox"/>	<input type="checkbox"/>	AZM400Z-ST-I1-1P2P-T	103003840
<input type="checkbox"/>	<input type="checkbox"/>	<input type="checkbox"/>	<input type="checkbox"/>	<input type="checkbox"/>	<input type="checkbox"/>	<input type="checkbox"/>	<input type="checkbox"/>	<input type="checkbox"/>	<input type="checkbox"/>	AZM400Z-ST-I2-1P2P	103003733
<input type="checkbox"/>	<input type="checkbox"/>	<input type="checkbox"/>	<input type="checkbox"/>	<input type="checkbox"/>	<input type="checkbox"/>	<input type="checkbox"/>	<input type="checkbox"/>	<input type="checkbox"/>	<input type="checkbox"/>	AZM400Z-ST-I2-1P2P-T	103003841
<input type="checkbox"/>	<input type="checkbox"/>	<input type="checkbox"/>	<input type="checkbox"/>	<input type="checkbox"/>	<input type="checkbox"/>	<input type="checkbox"/>	<input type="checkbox"/>	<input type="checkbox"/>	<input type="checkbox"/>	AZM400Z-ST2-2P2P-E	103003588
<input type="checkbox"/>	<input type="checkbox"/>	<input type="checkbox"/>	<input type="checkbox"/>	<input type="checkbox"/>	<input type="checkbox"/>	<input type="checkbox"/>	<input type="checkbox"/>	<input type="checkbox"/>	<input type="checkbox"/>	AZM400Z-ST2-2P2P-T-E	103003591
<input type="checkbox"/>	<input type="checkbox"/>	<input type="checkbox"/>	<input type="checkbox"/>	<input type="checkbox"/>	<input type="checkbox"/>	<input type="checkbox"/>	<input type="checkbox"/>	<input type="checkbox"/>	<input type="checkbox"/>	AZM400Z-ST2-I1-2P2P-E	103003724
<input type="checkbox"/>	<input type="checkbox"/>	<input type="checkbox"/>	<input type="checkbox"/>	<input type="checkbox"/>	<input type="checkbox"/>	<input type="checkbox"/>	<input type="checkbox"/>	<input type="checkbox"/>	<input type="checkbox"/>	AZM400Z-ST2-I1-2P2P-T-E	103003835
<input type="checkbox"/>	<input type="checkbox"/>	<input type="checkbox"/>	<input type="checkbox"/>	<input type="checkbox"/>	<input type="checkbox"/>	<input type="checkbox"/>	<input type="checkbox"/>	<input type="checkbox"/>	<input type="checkbox"/>	AZM400Z-ST2-I2-2P2P-E	103003725
<input type="checkbox"/>	<input type="checkbox"/>	<input type="checkbox"/>	<input type="checkbox"/>	<input type="checkbox"/>	<input type="checkbox"/>	<input type="checkbox"/>	<input type="checkbox"/>	<input type="checkbox"/>	<input type="checkbox"/>	AZM400Z-ST2-I2-2P2P-T-E	103003836
Actuator										AZM400-B1	103003508
Mounting set										MS-AZM400	103009179



The Schmersal Group

The privately-owned Schmersal Group has been developing and manufacturing products to enhance the safety at work for decades. The company was founded in 1945 and is represented by seven manufacturing sites on three continents and with its own companies and sales partners in more than 60 nations. In the demanding field of machine safety, the Schmersal Group is one of the international market and competence leaders. Based on a comprehensive product range, the company's approximately 2000 employees develop and design complete solutions for the safety of man and machine.

Customers of the Schmersal Group include „global players“ from mechanical engineering and plant manufacturing and machine users. They benefit from the comprehensive know-how of the company when it comes to the standard-compliant integration of safety technology in the production processes. Furthermore, Schmersal has special sector expertise in the application fields that demand high quality and special characteristics from safety switching systems. These include food production, the packaging industry, machine tool construction, lift engineering, heavy industry and the automotive industry.

Against the backdrop of increasing numbers of standards and directives, tec.nicum offers a comprehensive range of safety services as part of the Schmersal Group services division: Certified functional safety engineers advise customers on selecting suitable safety equipment, CE compliance assessments and risk assessment, on a word-wide basis.

Product ranges



Safe switching and monitoring

- Guard door monitoring (Safety switches)
- Command devices with safety function
- Tactile safety devices
- Optoelectronic safety devices

Safe signal processing

- Safety relay components
- Safety controllers
- Safety bus systems

Automation

- Position detection
- Command and signalling devices

Industries



- Elevators and Escalators
- Packaging
- Food
- Automotive
- Machine tools
- Heavy industry

Services



- Application support
- CE conformity assessment
- Risk assessment
- Upgrading / Retrofit
- Technical planning and implementation
- Training courses

Competences



- Machine safety
- Automation
- Explosion protection
- Hygienic design

www.schmersal.com



1.000 / L+W / 11.2015 / Teile-Nr. 103011494 / EN / Ausgabe 01

Precautions have been taken to assure accuracy of the information in this catalogue. Typographic or pictorial errors that are brought to our attention will be corrected in subsequent issues.

 **SCHMERSAL**
Safe solutions for your industry