

Selection Guide.....	122
Automation Organizer Suite.....	123
WindO/I-NV2.....	124
WindLDR.....	129
WindCFG.....	133
WindSRV.....	135
WindLGC.....	138

# Automation Software



[www.IDEC.com/software](http://www.IDEC.com/software)



Selection Guide

OI Touchscreens

PLCs





Automation Software

Power Supplies

Sensors

Communication

Barriers

Series	Automation Organizer Software Suite			WindSRV	WindLGC	WindMSG
	Wind O/I-NV2	WindLDR	WindCFG			
Appearance						
Page Number	124	129	133	135	138	visit <a href="http://www.IDEC.com/software">www.IDEC.com/software</a>
Application	OI Touchscreens	PLCs	System Configuration Tool for OI Touchscreens & PLCs	OPC Server for PLCs	SmartRelay	Character Displays

## Automation Organizer Suite

### A one-stop automation software package for all IDEC PLC and OI Touchscreens

Automation Organizer (AO), the IDEC software suite combining our popular PLC programming software (WindLDR) and OI programming software (WindO/I-NV2) with system configuration software (WindCFG), is made to enable you to see the layout of your system design and basic configuration of devices. AO gives you a powerful and easy-to-use tool to design, debug, and document control systems, saving valuable time and money.

#### FREE Upgrades

The Automation Organizer suite comes with free lifetime upgrades. Once you make the initial purchase, upgrades are absolutely free.



#### Part Number

Part Number	Description
SW1A-W1C	Automation Organizer software suite



WindO/I-NV2 software is the simplest programming tool for all IDEC OI Touchscreens. It is used to create projects or programs that can display information from a PLC, process status, or can be used to input data with virtual switches or keypads to make changes to a process. The objects are extremely easy to configure with the help of step-by-step navigation. It lets you quickly create colorful graphical screens in no time using drop-down menus and intuitive drag and drop functionality for the objects. A workspace is available to help you organize and manage projects, objects and screens.



All IDEC micro controllers are programmable with WindLDR ladder logic software. This icon-driven programming tool combines logic and intuition with an incredibly easy-to-use interface to allow you to take advantage of every MicroSmart feature. Even without ladder program experience, you can use the built-in editors, shortcuts and debuggers to configure programs.



WindCFG is a System Configuration tool. You can create a visual layout of your system design and basic configuration of the IDEC PLCs, OI Touchscreens, barcode readers, & other peripheral devices for the purpose of creating manuals or other documentation.

# Automation Organizer Suite - WindO/I-NV2

## Programming Software for IDEC OI Touchscreens

OI Touchscreens

PLCs

### Key Features

- Built-in Serial and Network Protocols
- Pass-thru function
- Extensive Image Library
- Intuitive Drag & Drop Functionality
- Flexible Screen Display for Efficient Editing
- Workspace – easy to manage projects & screens



It's as easy as 1, 2, 3!

Automation Software

### 1 Create

Creating a project is simple! Just name a project file and select your parameters (OI type and model, protocol type, and optional settings).

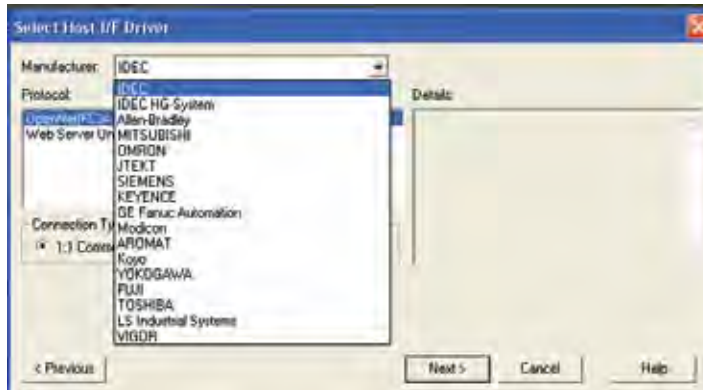

Power Supplies

### 2 Configure

Select a functional part and assign a device address. The other tabs allow you to change image, color, or add more parameters.

Drag and Drop Screen Design

Easy step-by-step configuration

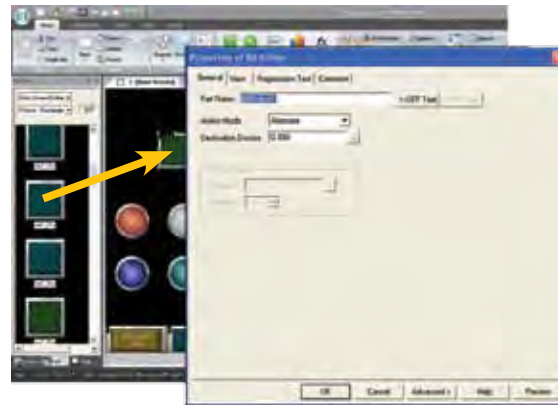

Sensors

Communication

### 3 Download

Once your project is ready to be downloaded to the touchscreen, select "Online" and then "Download." You can now debug or monitor your program as needed. It's as simple as that!



Barriers

## Create a powerful graphical display



### Extensive Image Library

A built-in symbol library provides over 7,000 bitmaps to help you create cutting-edge graphical screens. Image data from BMP and JPG files can also be imported.

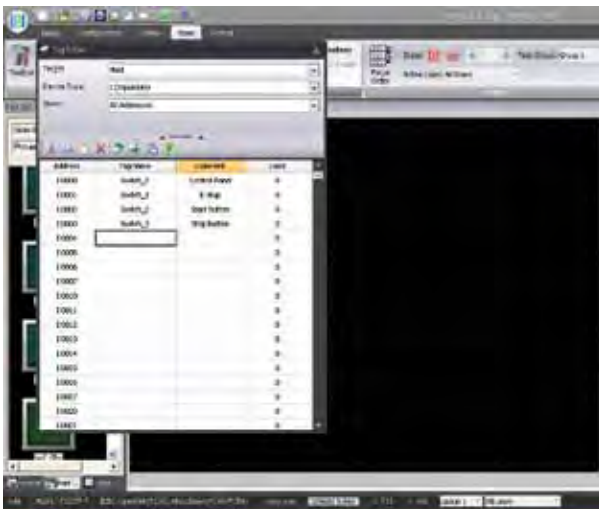

### Tag Database

You can create a database of device addresses, including Tag Names, which help you label each address to best match your information or documentation. By creating a Tag database, you can choose addresses used to read data from the PLC or Host device, or write data to the PLC or device. Even more convenient, if you have a list of IDEC PLC addresses already made in WindLDR, you can easily import it to the Tag Database.

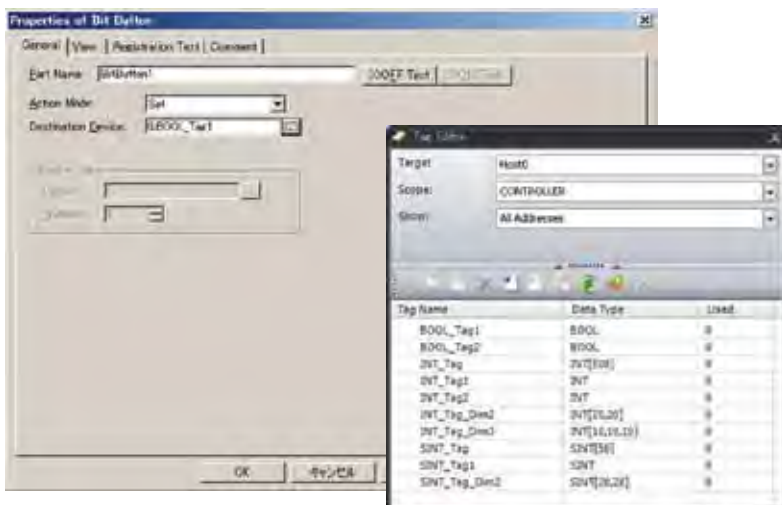

### Allen Bradley Logix Native Tag Import

The High-Performance models support "Allen Bradley Logix Native Tag Import," which means you can easily import any tag database file (L5K or CSV file) created with Allen Bradley PLC software. Once registered in the Tag Editor, you simply select the Tag name for your part.

OI Touchscreens

PLCs

Automation Software

Power Supplies

Sensors

Communication

Barriers



### Supports Standard Windows Fonts

These OI Touchscreens support all fonts used in Windows, including Stroke and 7 Segment Display fonts, making it possible to choose from a variety of text styles to create the look and feel you want to achieve.

### Multilingual Capabilities for Global Applications

The IDEC Touchscreen family supports many different languages. Using the Text Group function you can create a text database in Japanese, Chinese, Korean, Taiwanese, as well as Baltic, Cyrillic and other European languages. Plus, you can easily switch text messages from English to Japanese or any other supported language with the touch of a button.



### Project Conversion

A Zooming Conversion function makes it easy to convert existing program images and functional parts, created for a small display, to a larger display or vice versa. Don't waste time recreating projects for a different display when you can save time and energy by using this easy-to-use tool!

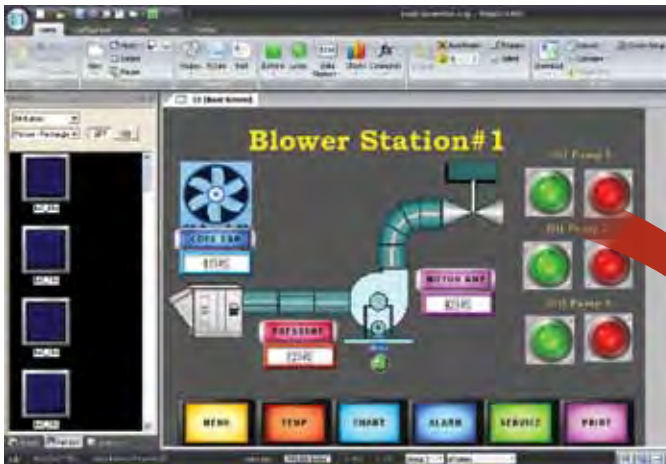



**Security Function**

When you have multiple users editing projects or displaying screens and parts, it may be necessary to have different levels of security and restrictions. With the Security Function, you can password protect programs, screens and parts from other users.



**Operation and Alarm Log Functions**

The operating log helps investigate, analyze and solve problems and system errors by checking who, when, what and where operations were performed. Plus, once you setup up the Alarm Log function for messages and alerts, it can monitor alarm conditions from a PLC and store historical events with a date and time stamp on a memory card (in CSV format). The high-performance series also meets ISA standards for visual alarm management.

Target Events for Record	Record Information						
	Sampling Time	User	Screen No.	Event Name	Part Name	Device	Change to
Power ON	X	-	X	X	-	-	-
Switch to Base Screens	X	X	X	X	-	-	X
Change Users	X	X	X	X	-	-	X
Change Operation Modes	X	X	X	X	-	-	X
Press Buttons	X	X	X	X	X	-	-
Write Data any Devices	X	X	X	X	-	X	X

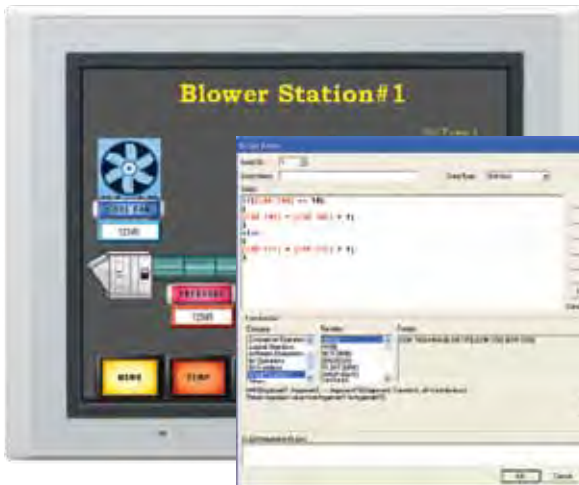

**Script Function**

Users with basic programming knowledge in "C" can use a Script function to combine conditional statements, mathematical operations and other functions to create simple and complex processes, reducing the programming required in the PLC. A Syntax Check function is also available providing easy program troubleshooting.



OI Touchscreens



### Switches, Pilot Lamps, and Meters

Hundreds of colorful pushbuttons, switches and meter images can give your display a realistic appearance mimicking a real panel. Pushbuttons and switches are used to set a bit, move data, switch screens or print screen images, while pilot lamps or multi-state lamps read and display statuses from single or multiple bits on the PLC or device.

PLCs



### Bar Graphs and Trend Charts

Use the Bar graphs and numerical displays to show range or flow for analog values from your PLC or device, or create Trend Charts to closely monitor critical data points. Display historical data (based on a fixed time period or event) with the option to show date & time on the x-axis or store it (in csv format) on the memory card or internal memory for easy viewing and data manipulation on your PC.

Automation Software

Power Supplies



### Recipe

A Recipe function allows you to conveniently set operational parameters, which can be individually defined for different processes. There are 1,024 available channels, which can store up to 8,192 parameters per channel. Plus you can easily upload or download parameters to and from your PLC.

Sensors

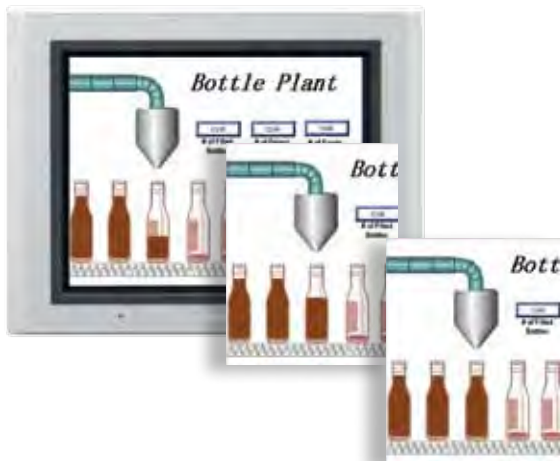

### Animation

Want to give your screen a "WOW" factor? It's simple to display animation by using the Picture Display function and configuration is a breeze. Simply import a series of images when using the Picture Display Function. Those images will then be displayed depending on the device value or constant time period.

Communication

Barriers



## Automation Organizer Suite - WindLDR

### Programming Software for IDEC PLCs

#### Key Features

- Online Edit
- Simulation Mode
- Comment download



Automation Organizer

# WindLDR



#### Single Platform for all IDEC PLCs

WindLDR is an excellent, long-term investment for your control solutions. It programs every IDEC PLC including the OpenNet Controller, MicroSmart and the fastest micro-controller on the market, MicroSmart Pentra. It's adaptable to whatever hardware you need today and down the road.

#### Simple-to-use Editors

Use the tag editor to access and edit coil data. Edit comments and rung comments. Simulation mode allows you to test your program in WindLDR to guarantee that it works the way you expected, rather than downloading it to your PLC.

#### Firmware Download

With WindLDR version 6.4 or later, you have the option to upgrade or downgrade your CPU system program. It's as simple as clicking on the checkbox in the Download dialog box. Now you can easily update your PLC system firmware with the click of a button.

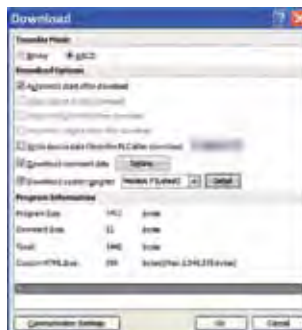

#### User-friendly Interfaces

Icon-based toolbars and drag-and-drop functionality make basic ladder programming accessible to anyone. But WindLDR also shows you how to display parameters and settings and how to input your parameters, and the built-in shortcuts and tutorials will keep you on the right track.

#### Free Lifetime Upgrade

Not only is WindLDR the easiest and most convenient ladder programming software on the market, it also comes with a very special price with no strings attached. Our software comes with a free-lifetime upgrade. That means that you no longer need to spend thousands of dollars for a software that has to be renewed every year costing you additional money. Save yourself money by using an IDEC PLC and WindLDR programming software.

### Online Editing

Shutting down for minor changes can be a major hassle, so WindLDR allows you to edit and download programs while the PLC is still in Run mode. You'll be able to make changes to the PLC, verify the results and cancel or accept these changes.

The Confirm and Cancel options allow users to select whether to permanently accept the changes (Confirm) or revert the program back to the original settings (Cancel).

This unique Debug tool allows users to download any changes in the program to a temporary memory location in the PLC. With this option, users can verify the changes they make before selecting whether to accept or cancel them.

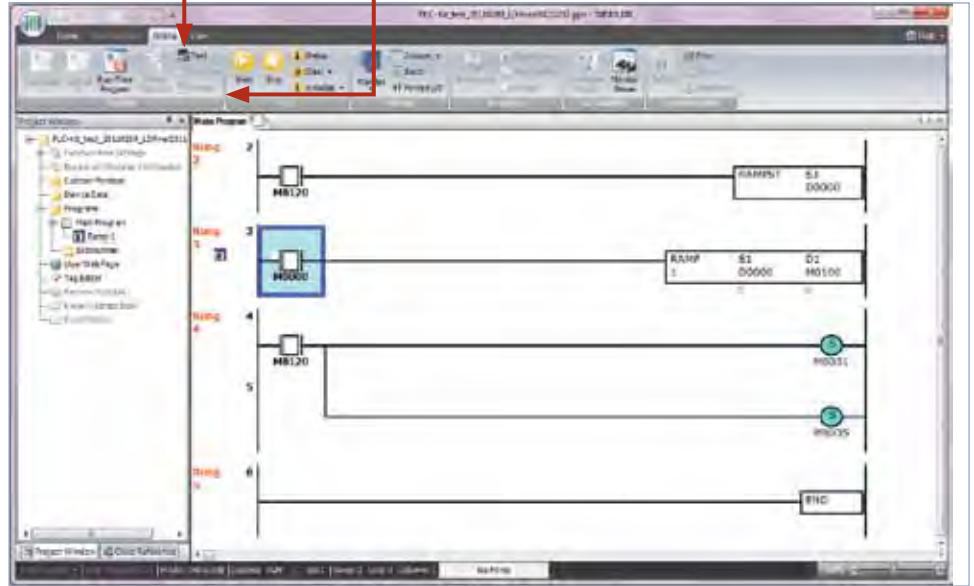

### Simulation Mode

WindLDR has a built-in simulation mode that allows users to write and debug programs without needing a PLC. Test your program in WindLDR to guarantee it works the way you expected, rather than downloading it to your PLC.

Simulating parameters in WindLDR program is extremely convenient and easy using built-in dialog boxes or point-and-click features.

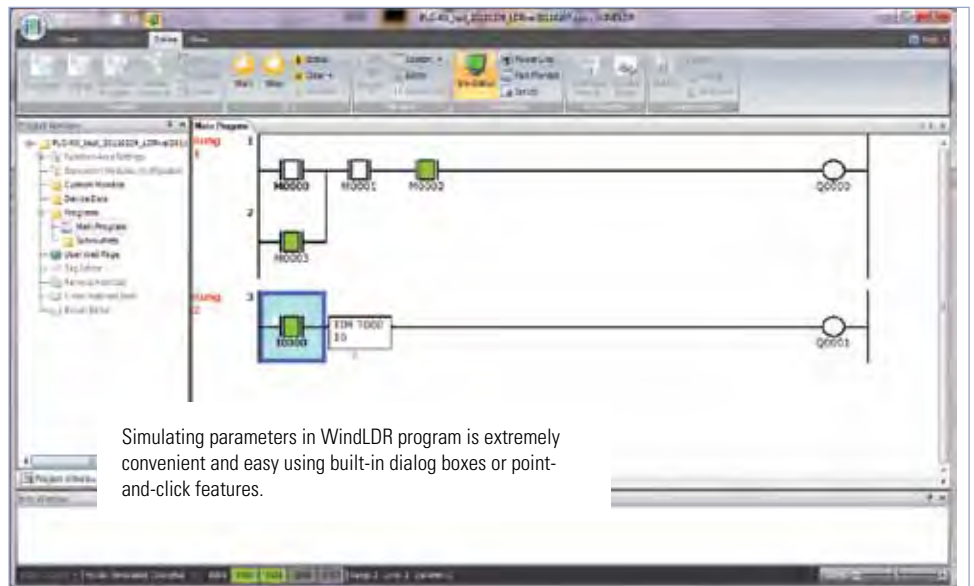

### Analog Macro

Setting up analog controls with WindLDR software just got a lot easier. The analog macro instruction allows users to point and select modules, signal and data type in a matter of seconds. And, all of these configurations convert into just one ladder line instruction.

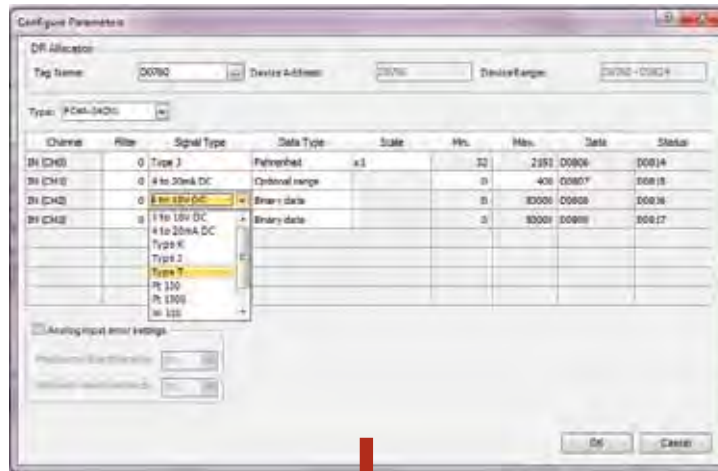

### Simple-to-use PID

Configuring PID loops with WindLDR software is a snap using the built-in PID dialog box. The PID dialog allows users to quickly select and fine tune the desired controls without needing to remember each and every parameter of a PID algorithm. A maximum of 56 PID loops can be utilized in the MicroSmart Pentra.

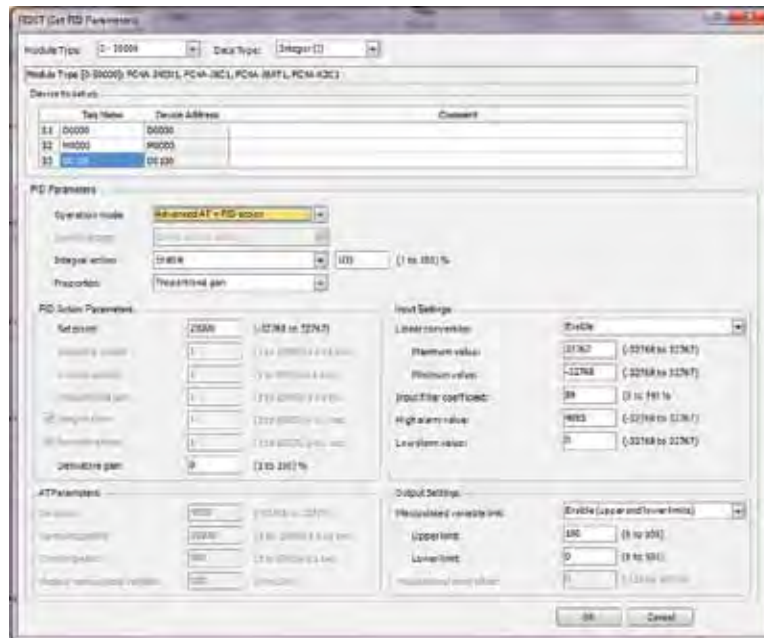

Powerful Debugging Tools

OI Touchscreens

PLCs

Comment Download Settings

The comment download settings allow users to choose whether to download Tag names, rung comments, custom monitor dialog boxes and file names into the MicroSmart Pentra. The biggest advantage of utilizing these settings is that once a program is retrieved from the PLC, all these important parameters will be available.

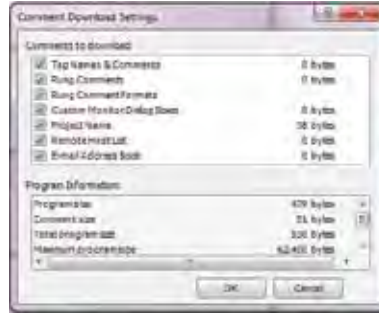

Users can create, save and download the custom monitor dialog into the MicroSmart Pentra controller.

Automation Software

Custom Monitor Dialog Box

Compile and enter a list of parameters you want to monitor, then save it and access it again and again, instead of re-entering your data every time.

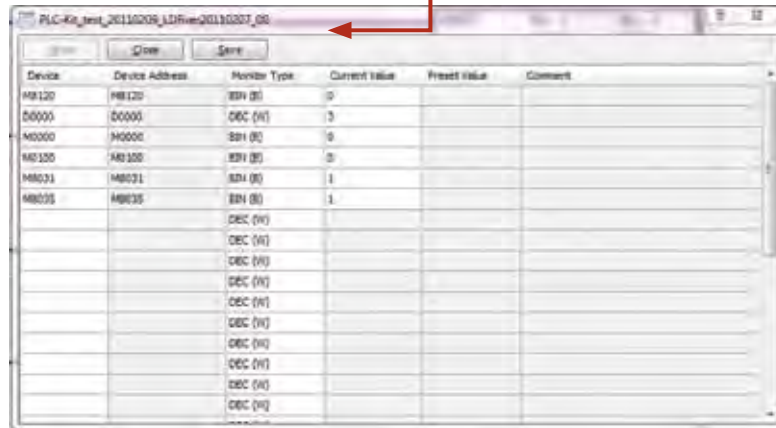

Power Supplies

Sensors

Bookmark Functions

Bookmark function is a great debugging tool. It allows users to quickly jump to a bookmarked location in the ladder program allowing for easier program modifications and updates.

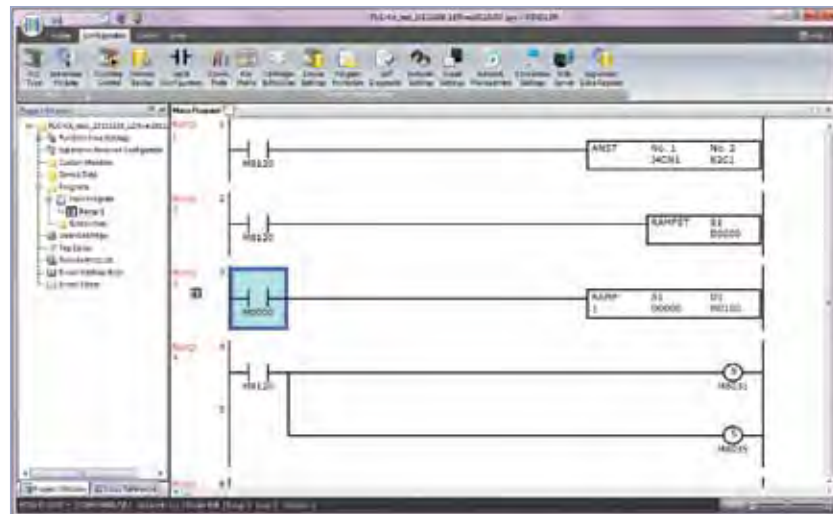

Communication

Barriers

## Automation Organizer Suite - WindCFG

### Configuration Tool for IDEC PLCs and OI Touchscreens

**Key Features**

- Create a visual layout of your system design for documentation
- Central Database for configuration and information
- Manage one single program file.
- Share Tag database between WindOI-NV2 and WindLDR SOFTWARE
- WindOI-NV2 and WindLDR can be launched directly from the system configuration screen



**WindCFG** is a System Configuration tool. It let's you create a visual layout of your system design and basic configuration of the IDEC PLCs and OI Touchscreens, Barcode Readers, & other peripheral devices for the purpose of manual or documentation.



**Central Database Configuration & Information :**

- In WindCFG, you can manage one single program file!  
Create a layout of the IDEC OI & PLC and launch WindOI-NV2 and WindLDR directly from the configuration system to build the program files.

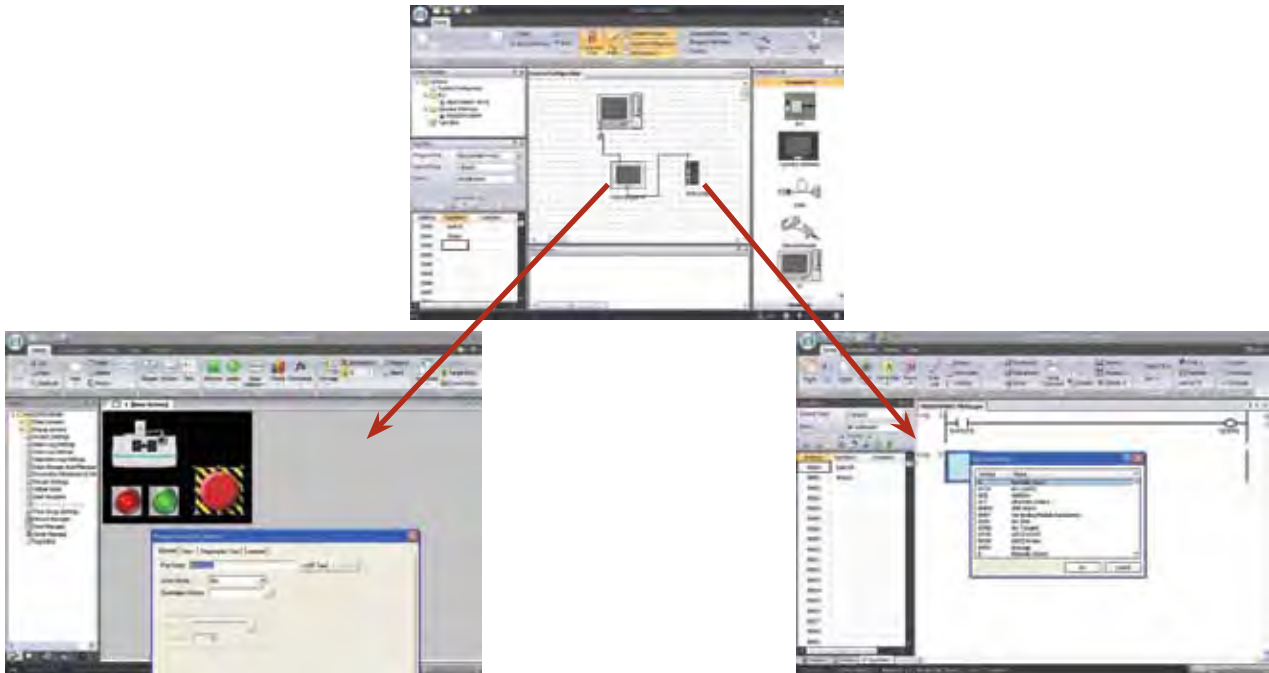

OI Touchscreens

PLCs

Automation Software

Power Supplies

Sensors

Communication

Barriers

Address, Tag Names, Comments, and other type of data will be easily accessible and shared between WindO/I-NV2 & WindLDR software.

OI Touchscreens

PLCs

Automation Software

Power Supplies

Sensors

Communication

Barriers

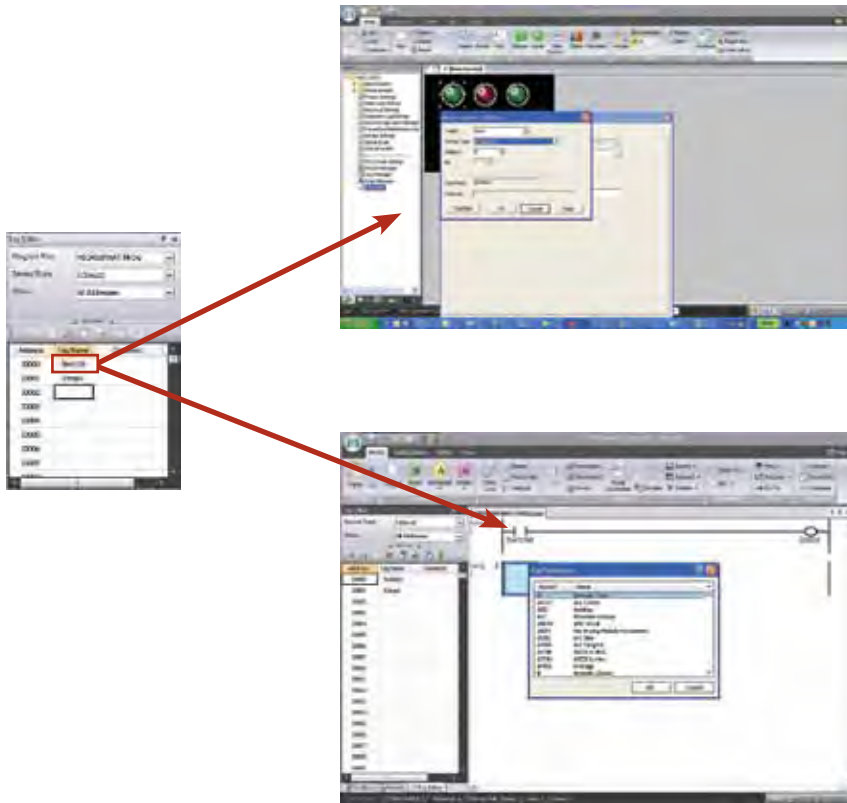

**Create a visual layout of your system design for documentation:**

- Print configuration of each component used & the option to print BOM (Bill of Material) for documentation purposes.
- View cable part numbers and wiring diagrams for documentation purposes

The composite image illustrates the documentation capabilities of the software. On the left, a printer is shown printing a document. The main part of the image is a screenshot of the software interface showing a wiring diagram and a BOM table. The wiring diagram shows a PLC (RS-232C) connected to an H229 (RS-232C) terminal. The BOM table lists the components used in the system configuration.

**Part Number: H90Z-XC278**  
 Connections table for the H229 (RS-232C type) Serial 2 and the IDEC MICROmount or the MicroMini FX Series.

The following wiring is for the H229 and the IDEC MICROmount

PLC (RS-232C) Mini D25P connector			H229 (RS-232C) Terminal	
Name	Color	Pin No.	Pin No.	Alarm
5C	Black	1	1	RD
5C	Yellow	2	2	BD
5D	Blue	3	3	SL
5E	Green	4	4	CS
5C	Brown	5	5	SO
5C	Grey	6		
5C	Red	7		
5C	White	8		
Work	-	Cover		

**Bill of Materials for System Configuration**

Part No.	Product Name	Quantity	Comment
PC	Computer	1	PC
H229-3822V-FW	H229 Overcoil Interface	1	5.7" 256 color touchscreen (DC24V) Resolution: 320x240 Max. Part: RS-232C/485/422 Reference Part: RS-232C Cf Card: Not support Ethernet: Not support Bezel Color Light Gray
PCSA-D22K3	PCSA MicroSmart Peritra	1	Rated Voltage: 24V DC Embedded I/Os: 16in/16out Output Type: Transistor (Sink) Max.I/Os: 512 Program Capacity: 62.4K bytes Maximum Analog I/O: 56 Data Memory: DR=48000 TR=256 OIT=256, IR=2048
PCSA-CF2K	PCSA Overcoil Controller	1	Rated Voltage: 24V DC Embedded I/Os: 0in/0out Output Type: - Max.I/Os: 480 Program Capacity: 32K words Maximum Analog I/O: 42in/14out HSC: 100us (Sink) Data Memory: DR=9000 TR=256 OIT=256 IR=2048
BRYPH01C-D130	BRYPH01H CCD Gun	1	1D Handheld Barcode Reader

## WindSRV Software

### OPC Server for IDEC PLCs

#### Key Features

- On-line full time
- Support MicroSmart Pentra 32-bit and floating point
- Support Ethernet and modem communications
- Built-in Quick Client interface



#### A True Plug-and-Play OPC Server

Looking for a fast and flawless controls solution? Want your control systems centralized, easy-to-manage and able to take advantage of all the components you already have? WindSRV, also known as KEPServerEX, is an OPC server that provides direct connectivity between client applications and IDEC PLCs. It's a true plug-and-play OPC Server with effortless data management, acquisition, monitoring and control.

Part Number	Description
WINDSRV-1	Single device connection. One PLC can be connected to the server.
WINDSRV-4	Four device connections. Up to 4 PLCs can be connected to the server.
WINDSRV-U	Unlimited device connections. Up to 100 PLCs can be connected to the server.

### Use Microsoft Excel

#### Using Microsoft Excel as Client Applications

Using Microsoft Excel, available on most PCs, customers can create a visual central monitoring station quickly and effectively. System status such as sensor inputs, motor outputs, etc. can be monitored and controlled. It's a cost-effective, real-time central monitoring system that can be customized to your needs. With just KEPServerEX server and Excel, up to 100 PLCs can be monitored and controlled in real time.

#### Sample application using Microsoft Excel

Input and output status such as switches, sensors, flow meters, E-stops, motors, etc. can be monitored in real time.

Output devices such as motors and valves, can be controlled with just a single click.

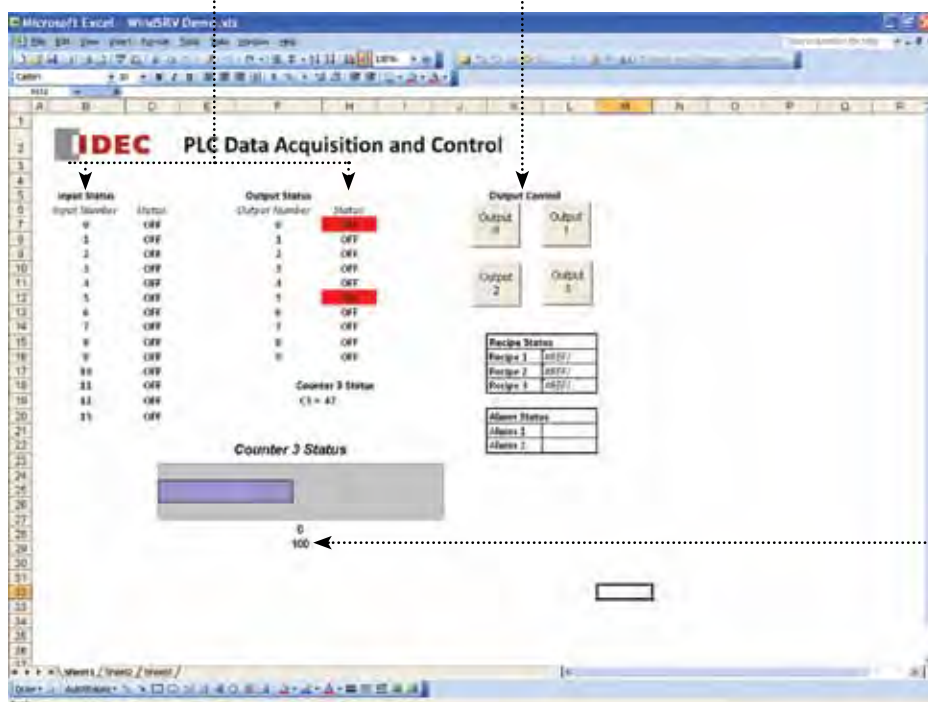

Using the graph feature in Excel, users can create a custom presentation to monitor water tank levels or production counts. And that isn't all, there is so much more you can do and create using Excel.

## Easy to use and setup

### It's as simple as 1-2-3

KEPServerEX is designed to allow quick and easy configuration of your communications.

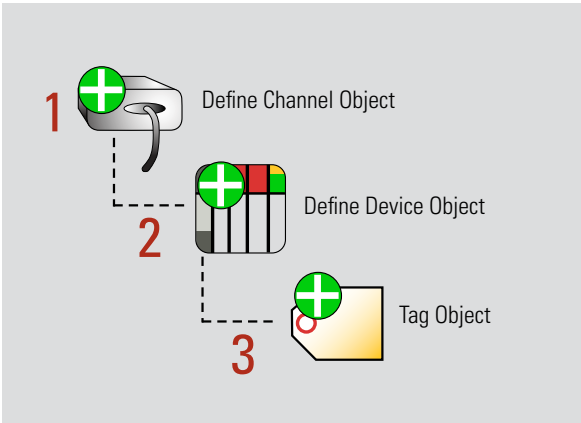

#### Step 1

##### Select a driver

Each protocol or driver used in the KEPServerEX server and project is referred to as a channel. Channels are specific communication drivers such as RS232C, Ethernet or Dial-up modems. A project can consist of many channels.

#### Step 2

##### Specify the device

Configure the PLC you want to communicate with the server. KEPServerEX supports MicroSmart Pentra, MicroSmart, OpenNet controllers and even older FA and Micro3 series.

#### Step 3

##### Create tags

A tag is memory allocation in the PLC. You can monitor input, outputs, internal relays and data registers. You can also create a Tag Group that allows you to monitor each set of PLC parameters such as I/O status, alarm conditions, etc.

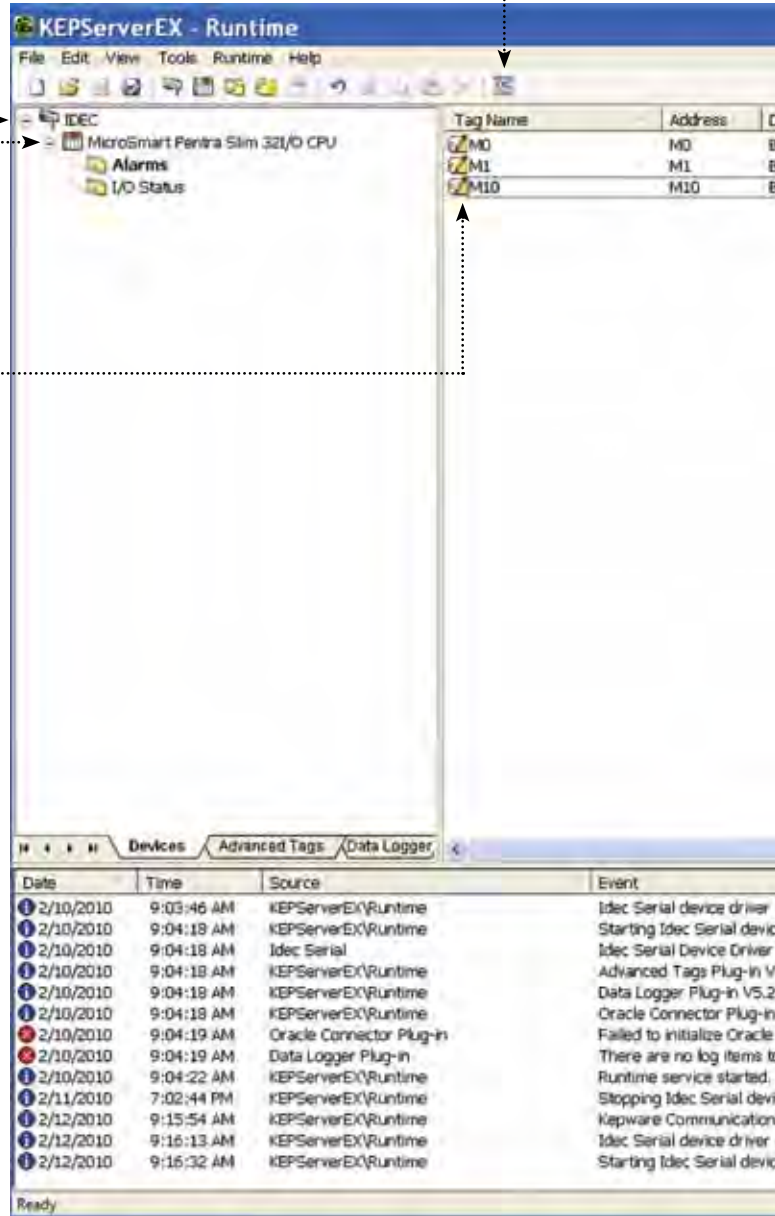



## Quick Client

Once tags or tag groups are created in your project, click on the Quick Client icon to start monitoring these parameters. Quick Client is a quick way to determine if the server is connected to the PLCs.



## Auto Demotion

This device allows a driver to temporarily place a KEPServerEX device off-line in the event that a physical device is not responding. By placing a non-responsive device off-line, the driver can continue to optimize communication with the device.

## Tag Creation and Management

Tag Grouping, Drag and Drop editing and CSV Import/Export are basic features to make it easier for you to organize your next project. Another feature that you will find useful is Automatic Tag Database Generation. KEPServerEX supports automatic regeneration of tags for select communication drivers. Drivers that support this feature can either read tag information directly from a device or generate tags from stored tag data. You no longer need to enter OPC tags into the server.

## On-Line Full-time

KEPServerEX is on-line all the time, allowing your application to be modified while the server is communicating with client applications. Almost all parameters can be changed while the server is running, including com port and baud rate configuration, along with tag editing and additions.

## Supports MicroSmart Pentra 32-bit registers and floating point data

KEPServerEX version 5 now supports MicroSmart Pentra complete addressing, including 32-bit data and floating point data.

## WindLGC Software

### Programming Software for IDEC SmartRelay

#### Key Features

- Function Block or Ladder programming
- Online Test features
- Program Simulation

#### Create

Create, simulate, test and save your program using drag and drop functions. Eight basic functions make it easy to create a simple switching program in just a matter of seconds, while 31 additional special functions make it just as uncomplicated to create complex programs. Choose function block diagrams or ladder programming; you can always convert from one to the other with the click of an icon.

#### Simulate

Offline program simulation (without the need for an actual SmartRelay) enables testing of the entire program from a PC.

#### Test

Once you verify your control program works in Simulation Mode, WindLGC allows you to directly monitor your IDEC SmartRelay during operation using an Online Test mode.

#### Document

You can create and save your WindLGC program as a PDF, BMP or JPG file. Professional documentation is included with all the necessary configuration information, such as comments and program settings.



Part Number	Description
FL9Y-LP1CDW	SmartRelay programming software

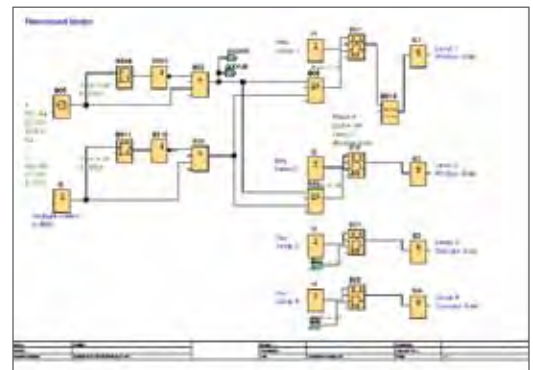
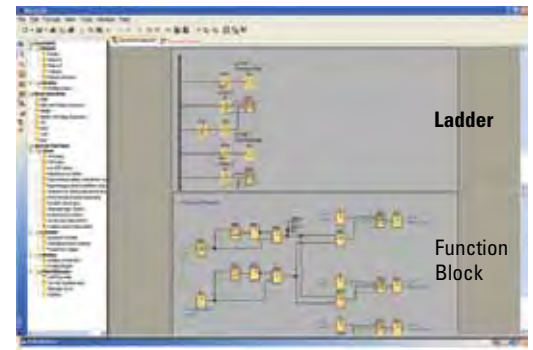

**Visit IDEC at [www.IDEC.com/smartrelay](http://www.IDEC.com/smartrelay) for additional information on FREE software upgrades, demo software, FAQs, manuals and brochures.**